

Quick Chill S/S, Chrome, & Tarnish Free Brass Square Column "T" and Pass-Thru Towers



All Quick Chill towers are available in stainless steel, polished chrome or tarnish free brass finish. Includes sanitary faucets with black plastic spouts and restriction kit to balance each faucet in the field. Faucet knobs NOT included.

"T" towers are 12 15/16" high overall. For towers with 3 to 7 taps, column is 4 5/8" square with 6" square plate at the base. * For towers with 8 taps, column is 7 5/8" square with 9" rectangular plate at the base. Faucet centers (distance from center of one faucet to center of the next faucet) are 2 3/4". Tee is 6 7/16" deep. Distance from countertop to bottom of tee is 9 1/2".

Pass-Thru towers are 12 15/16" high overall. Columns are 4 5/8" square with 6" square plates at each base. Distance between column centers is 16 1/2". Tee is 33 1/8" wide and 6 7/16" deep. Distance from countertop to bottom of tee is 9 1/2".

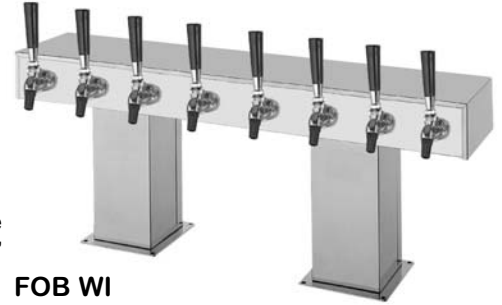

FOB WI

Need an extra tall "T" or Pass-Thru tower for growlers? No Problem! Two upgraded sizes can increase counter-to-faucet height by 2⁵/₈" or 3³/₄". Call for pricing and availability.

"T" Towers

Model#	#Taps	Finish	Width	Cost
TT3SS	3	S/S	9 1/8"	\$355.00
TT3PC	3	Chrome	9 1/8"	395.00
TT3TF	3	TF Brass	9 1/8"	460.00
TT4SS	4	S/S	11 7/16"	430.00
TT4PC	4	Chrome	11 7/16"	445.00
TT4TF	4	TF Brass	11 7/16"	570.00
TT5SS	5	S/S	14 5/8"	530.00
TT5PC	5	Chrome	14 5/8"	565.00
TT5TF	5	TF Brass	14 5/8"	685.00
TT6SS	6	S/S	17 3/4"	595.00
TT6PC	6	Chrome	17 3/4"	620.00
TT6TF	6	TF Brass	17 3/4"	725.00
TT7SS	7	S/S	20 1/8"	640.00
TT7PC	7	Chrome	20 1/8"	705.00
TT7TF	7	TF Brass	20 1/8"	835.00
TT8SS*	8	S/S	20 7/8"	705.00
TT8PC*	8	Chrome	20 7/8"	765.00
TT8TF*	8	TF Brass	20 7/8"	885.00



Lead Time

3-6 Days from date of order

Pass-Thru "Bridge" Towers

Model#	#Taps	Width	Finish	Faucet Centers	Column Centers	Cost
BT8BSS	8	33 1/8"	S/S	4 1/8"	16 1/2"	\$1015.00
BT8BPC	8	33 1/8"	Chrome	4 1/8"	16 1/2"	1085.00
BT8BTF	8	33 1/8"	TF Brass	4 1/8"	16 1/2"	1105.00
BT10BSS	10	33 1/8"	S/S	3"	16 1/2"	1175.00
BT10BPC	10	33 1/8"	Chrome	3"	16 1/2"	1270.00
BT10BTF	10	33 1/8"	TF Brass	3"	16 1/2"	1290.00
BT12BSS	12	33 1/8"	S/S	2 3/4"	16 1/2"	1270.00
BT12BPC	12	33 1/8"	Chrome	2 3/4"	16 1/2"	1340.00
BT12BTF	12	33 1/8"	TF Brass	2 3/4"	16 1/2"	1400.00
BT16BSS	16	44 1/4"	S/S	2 3/4"	22"	1760.00
BT16BPC	16	44 1/4"	Chrome	2 3/4"	22"	1845.00
BT16BTF	16	44 1/4"	TF Brass	2 3/4"	22"	1960.00
BT20BSS	20	55 1/8"	S/S	2 3/4"	27 1/2"	1965.00
BT20BPC	20	55 1/8"	Chrome	2 3/4"	27 1/2"	2050.00
BT20BTF	20	55 1/8"	TF Brass	2 3/4"	27 1/2"	2190.00

Quick Chill Glycol Towers Include...



New! 525 Series "PERL" Stainless Steel Sanitary Faucets with either a polished chrome or tarnish free brass exterior. The 525 series faucets can be upgraded to the new 575 series with push back creamer action to add just the right amount of foam to enhance presentation. Also included are S/S downtubes and patented restriction kits.

QUICK CHILL



1 1/2" screw-in replacement shanks for Quick Chill Towers with flat faucet surface
 #C27849 Chrome... \$19.95
 #C27849PB Brass.....19.95

Air Shaft Square Column "T" Towers



Available in stainless steel, polished chrome or tarnish free brass finish. Includes standard beer faucets. Towers are insulated and come with 2' of 3/16" ID beer tubing per faucet, with male beer fittings attached at ends of line. Faucet knobs NOT included. Faucet Centers are 2 3/4".

Towers are 12 15/16" high overall. Column is 4 5/8" square with 6" square plate at the base.

Model#	#Taps	Finish	Width	Cost
3780-3B	3	S/S	9 1/8"	\$305.00
3780-3BPC	3	Chrome	9 1/8"	320.00
3780-3BTF	3	TF Brass	9 1/8"	390.00
3780-4B	4	S/S	11 7/16"	365.00
3780-4BPC	4	Chrome	11 7/16"	385.00
3780-4BTF	4	TF Brass	11 7/16"	490.00
3780-5B	5	S/S	14 5/8"	430.00
3780-5BPC	5	Chrome	14 5/8"	465.00
3780-5BTF	5	TF Brass	14 5/8"	570.00
3780-6B	6	S/S	17 3/4"	525.00
3780-6BPC	6	Chrome	17 3/4"	580.00
3780-6BTF	6	TF Brass	17 3/4"	675.00

New!! Quick Chill Winged Single Column, "T" & Bridge Towers S/S, Chrome, & Tarnish Free Finishes With & Without Lighted Badges

Quick Chill Winged Towers feature a unique "aerodynamic styled" wing columns and crossbars in S/S, polished chrome, and tarnish-free brass. S/S and polished chrome models include Sanitary S/S Faucets with polished chrome finish. Tarnish free brass units include Sanitary S/S faucets with tarnish free brass finish. Black faucet handles not included. All models are glycol cooled with aluminum heat exchanger, S/S product tubes, copper glycol lines and include restriction balancing kits. Can be ordered with or without Illuminated medallions with white badges. Brand I.D. badges are available from the beer wholesaler. FOB WI.

Quick Chill Single Column "Winged" Glycol Towers Without & With Lighted Badges



WDA-2BPCIM

#Taps	Description	Part #	Price	Lighted Part#	Price
1	Brushed S/S	WDA-1B	\$355.00	WDA-1BIM	\$480.00
1	Polished Chrome	WDA-1BPC	370.00	WDA-1BPCIM	505.00
1	Tarnish Free Brass	WDA-1BTF	425.00	WDA-1BTFIM	575.00
2	Brushed S/S	WDA-2B	485.00	WDA-2BIM	645.00
2	Polished Chrome	WDA-2BPC	510.00	WDA-2BPCIM	675.00
2	Tarnish Free Brass	WDA-2BTF	580.00	WDA-2BTFIM	770.00
3	Brushed S/S	WDA-3B	570.00	WDA-3BIM	765.00
3	Polished Chrome	WDA-3BPC	600.00	WDA-3PCIM	805.00
3	Tarnish Free Brass	WDA-3BTF	685.00	WDA-3BTFIM	920.00

Quick Chill Winged "T" Glycol Towers Without & With Lighted Badges



WTT-6BPC

#Taps	Description	Part #	Price	Lighted Part#	Price
4	Brushed S/S	WTT-4B	\$570.00	WTT-4BIM	\$745.00
4	Polished Chrome	WTT-4BPC	605.00	WTT-4BPCIM	775.00
4	Tarnish Free Brass	WTT-4BTF	685.00	WTT-4BTFIM	860.00
5	Brushed S/S	WTT-5B	640.00	WTT-5BIM	850.00
5	Polished Chrome	WTT-5BPC	700.00	WTT-5BPCIM	885.00
5	Tarnish Free Brass	WTT-5BTF	765.00	WTT-5BTFIM	980.00
6	Brushed S/S	WTT-6B	705.00	WTT-6BIM	960.00
6	Polished Chrome	WTT-6BPC	735.00	WTT-6BPCIM	995.00
6	Tarnish Free Brass	WTT-6BTF	840.00	WTT-6BTFIM	1100.00
8	Brushed S/S	WTT-8B	850.00	WTT-8BIM	1210.00
8	Polished Chrome	WTT-8BPC	895.00	WTT-8BPCIM	1255.00
8	Tarnish Free Brass	WTT-8BTF	1020.00	WTT-8BTFIM	1380.00

Quick Chill Winged Pass Thru Glycol Towers Without & With Lighted Badges



WTT-6BPCIM

#Taps	Description	Part #	Price	Lighted Part#	Price
8	Brushed S/S	WBT-8B	\$965.00	WBT-8BIM	\$1315.00
8	Polished Chrome	WBT-8BPC	1010.00	WBT-8BPCIM	1365.00
8	Tarnish Free Brass	WBT-8BTF	1155.00	WBT-8BTFIM	1505.00
10	Brushed S/S	WBT-10B	1095.00	WBT-10BIM	1545.00
10	Polished Chrome	WBT-10BPC	1150.00	WBT-10BPCIM	1600.00
10	Tarnish Free Brass	WBT-10BTF	1315.00	WBT-10BTFIM	1765.00
12	Brushed S/S	WBT-12B	1235.00	WBT-12BIM	1785.00
12	Polished Chrome	WBT-12BPC	1300.00	WBT-12BPCIM	1845.00
12	Tarnish Free Brass	WBT-12BTF	1485.00	WBT-12BTFIM	2030.00



WTT-6BPC



←WBT-12BPCIM→

Copper, Brass, Chrome & S/S Angular "T", Round Pass-Thru, & Captain Wheel Towers

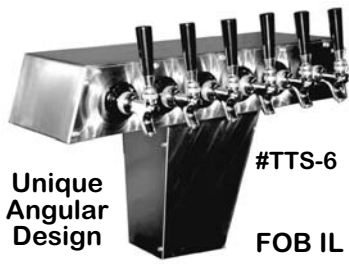

Unique Angular Design

#TTS-6

FOB IL

Glycol Only. Pre-assembled towers are available in brass, chrome, copper and brushed stainless steel finishes, include faucets and shanks with compression-fitting elbows (beer line not included). Bottom mounted through bar top, bolts and gasket included. Removable top allows for repairs in the field. 6" deep x 14 1/2" high overall. Width varies with number of taps. Towers include individual aluminum blocks with a polyethylene glycol heat exchanger and 5 feet of 3/16" line (insulated in a bundle). Towers have square 4 1/2" x 4 1/2" base flange, column widens to 7" x 5" at top of box.

9 and 10 Tap Towers Available
Call for Details



Lead Time

Allow 3 to 4 weeks from order date

#Taps	Faucet Center*	Brass	Glycol Ready**	Chrome	Glycol Ready**	Copper	Glycol Ready**	Brushed S/S	Glycol Ready
3	4 1/2"	TTB-3	\$630.00	TTC-3	\$690.00	TTP-3	\$690.00	TTS-3	\$485.00
4	3"	TTB-4	660.00	TTC-4	715.00	TTP-4	715.00	TTS-4	510.00
5	3"	TTB-5	715.00	TTC-5	770.00	TTP-5	770.00	TTS-5	570.00
6	3"	TTB-6	770.00	TTC-6	830.00	TTP-6	830.00	TTS-6	625.00
7	3"	TTB-7	840.00	TTC-7	900.00	TTP-7	900.00	TTS-7	685.00
8	3"	TTB-8	890.00	TTC-8	955.00	TTP-8	955.00	TTS-8	740.00

*Faucet Center is distance from center of one faucet to the next.

**Air shaft ready angular "T" towers also available with a 3-1/2" O.D. (3" I.D.) PVC down tube. Call for pricing.

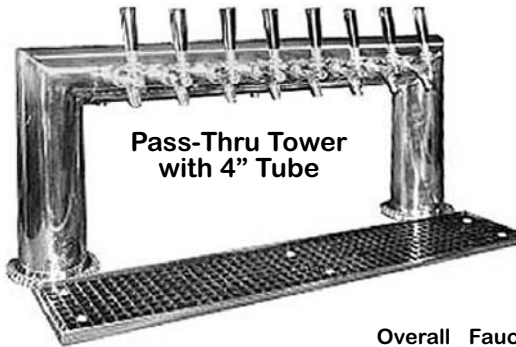

Pass-Thru Tower with 4" Tube

Glycol-ready towers are bottom-mounted through the bar top, bolts included. Stationary foot ring must be bolted from underneath. Bottom access panel for servicing. All models have faucets facing one side. Many more models available, including dual service/island style. Also available as an air cooled tower at a lesser cost, call for pricing. Decorative metal insignia on back. Include 5 feet of 3/16" restriction choke line and 3/8" ID plastic cooling lines, aluminum taped and foam taped. Specially designed bar rail drip trays available, extend under the pass-thru for easy clean-up. Call for more details.



Lead Time

Allow 2-4 weeks from date of order

FOB IL



#Taps	Overall Width	Faucet Centers*	Brass	Glycol-Ready Cost**	Chrome	Glycol-Ready Cost**	S/S	Glycol-Ready Cost**	Copper	Glycol-Ready Cost**
6	34"	3 3/4"	PTB-6	\$1185.00	PTC-6	\$1280.00	PTS-6	\$1280.00	PTP-6	\$1385.00
7	34"	3 1/4"	PTB-7	1240.00	PTC-7	1330.00	PTS-7	1330.00	PTP-7	1435.00
8	34"	3"	PTB-8	1295.00	PTC-8	1390.00	PTS-8	1390.00	PTP-8	1495.00
9	34"	2 1/2"	PTB-9	1350.00	PTC-9	1445.00	PTS-9	1445.00	PTP-9	1550.00
10	37"	3"	PTB-10	1400.00	PTC-10	1495.00	PTS-10	1495.00	PTP-10	1600.00
11	43"	3"	PTB-11	1470.00	PTC-11	1585.00	PTS-11	1585.00	PTP-11	1690.00
12	43"	3"	PTB-12	1545.00	PTC-12	1750.00	PTS-12	1750.00	PTP-12	1745.00
14	49"	3"	PTB-14	1680.00	PTC-14	1825.00	PTS-14	1825.00	PTP-14	1850.00
16	55"	3"	PTB-16	1760.00	PTC-16	1905.00	PTS-16	1905.00	PTP-16	1925.00

Up to 24 taps available, call for pricing

*Faucet Center is distance from center of one faucet to the next.

**also available as air shaft tower. Call for pricing.

Captain's Wheel Towers

Wood finished Captain's Wheel has 30" diameter (including spoke handles). High luster polished brass faucets (brushed stainless steel also available, please specify) and brass mirror-like finish between spokes make this an attractive decorative tower. Countertop or wall mount available, please specify when ordering. **Countertop Models** feature 4" diameter brass cylinder at base for bottom mounting. Rear is accessible for servicing. Back made of stained wood with center brass strip. Faucets are 14" from countertop. **Wall Mount Models** can be secured directly to a wall and can be used as airshaft or ordered with aluminum blocks and heat exchanger for glycol applications (add \$20.00 per faucet). Deep drain pan (36"W x 8"D x 1"H) recommended.

Model#	Description	Air Shaft Cost
CW-101	1 tap tower	\$825.00
CW-102	2 tap tower	865.00
CW-103	3 tap tower	905.00
CW-104	4 tap tower	935.00
CW-105	5 tap tower	975.00
CT36X8	Brass countertop drain tray	200.00
CS36X8*	Brass flush mount drain tray	230.00

*Flush mount drain tray has additional 1" flange on all sides



Lead Time Allow 3-5 weeks from order date

Octagonal Column Towers

All towers include faucets and shanks with 1/4" bore, base plates with inner and outer mounting brackets, integral surface mount drain pan with base plate, removable grids and 1/2" male pipe thread drain fittings. **Can be special ordered without drain pan assembly, call for pricing.**

Knobs NOT included FOB MI

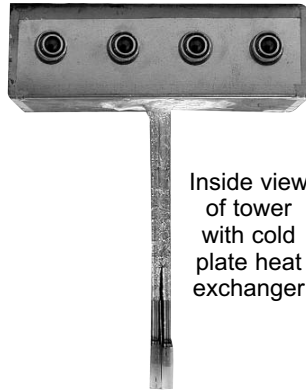

Inside view of tower with cold plate heat exchanger

Air Cooled Towers are insulated and include 6 feet of 3/16" ID vinyl beer line.

Glycol Towers include the molded aluminum cooling block with 3/8" copper glycol recirculation lines (barbed at end) and 3/16" ID stainless steel beer product lines (barbed at end). Both glycol and beer product lines extend to the base of the tower. Entire assembly is foamed-in-place. Also includes the cold plate accessory above as well as glycol poly lines, 6 feet of 3/16" vinyl beer line, aluminum tape wrap, insulation, reducers, splicers and clamps for connection to 3/8" lines.

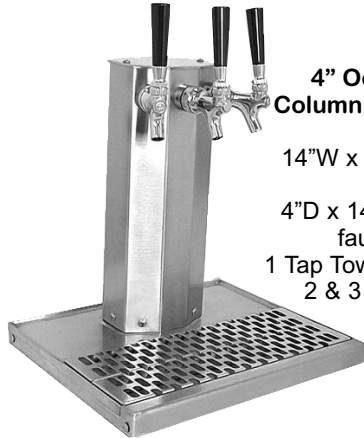

4" Octagonal Single Column Towers with Drain Pans

14"W x 12"D x 11 1/8"H drain pans

4"D x 14 1/2"H columns, 10" faucet clearance

1 Tap Towers: 3 7/8"W columns
2 & 3 Tap Towers: 5"W columns

Model#	#Taps	Finish	Air	
			Cooled	Glycol
CT1SS-BT	1	Grain S/S	\$335.00	\$595.00
CT1MF-BT	1	Mirror S/S	405.00	665.00
CT1PB-BT	1	Brass	490.00	745.00
CT2SS-BT	2	Grain S/S	435.00	675.00
CT2MF-BT	2	Mirror S/S	505.00	760.00
CT2PB-BT	2	Brass	580.00	840.00
CT3SS-BT	3	Grain S/S	535.00	790.00
CT3MF-BT	3	Mirror S/S	605.00	855.00
CT3PB-BT	3	Brass	675.00	950.00



Lead Time

Granular S/S models require 1-2 weeks to ship. Mirror S/S and polished brass towers require 2-3 weeks.



4" Octagonal Single Column T-Towers with Drain Pans

12"D x 1 1/8"H drain pans

5"D x 5"H box (approximate)

15 5/8"H column with box on top, 10" faucet clearance

Model#	#Taps	Width	Finish	Air	
				Cooled	Glycol
BT4SS-BT	4	14"	Grain S/S	\$410.00	\$865.00
BT4MF-BT	4	14"	Mirror S/S	660.00	910.00
BT4PB-BT	4	14"	Brass	735.00	985.00
BT5SS-BT	5	17"	Grain S/S	720.00	105.00
BT5MF-BT	5	17"	Mirror S/S	780.00	1060.00
BT5PB-BT	5	17"	Brass	875.00	1150.00
BT6SS-BT	6	20"	Grain S/S	845.00	1150.00
BT6MF-BT	6	20"	Mirror S/S	910.00	1215.00
BT6PB-BT	6	20"	Brass	100.00	1305.00
BT8SS-BT	8	26"	Grain S/S	1095.00	1475.00
BT8MF-BT	8	26"	Mirror S/S	1180.00	1565.00
BT8PB-BT	8	26"	Brass	1310.00	1695.00

Octagonal Column

Mounting Details
Screws Included

Top Column Mounting Bracket

Bottom Column Mounting Bracket

Drain Pan w/ Double Splash Grids

Base Plate

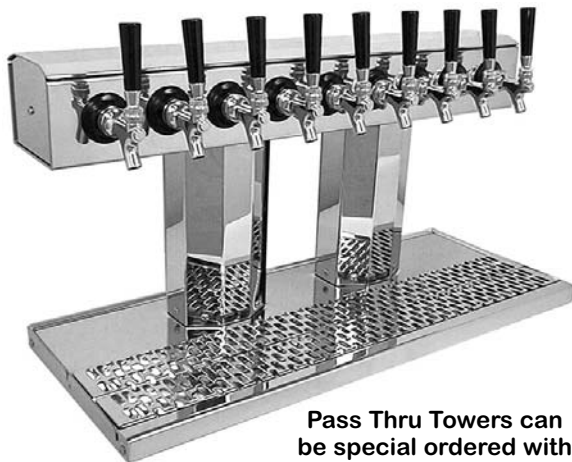

4" Octagonal Double Column Pass-Thru Towers with Drain Pans

12"D x 1 1/8"H drain pans

5"D x 5"H box (approximate)

15 5/8"H columns with box on top, 10" faucet clearance

Model#	#Taps	Width	Finish	Air	
				Cooled	Glycol
BT10SS-BT	10	32"	Grain S/S	\$1325.00	\$1780.00
BT10MF-BT	10	32"	Mirror S/S	1435.00	1885.00
BT10PB-BT	10	32"	Brass	1585.00	2030.00
BT12SS-BT	12	38"	Grain S/S	1540.00	2060.00
BT12MF-BT	12	38"	Mirror S/S	1675.00	2185.00
BT12PB-BT	12	38"	Brass	1835.00	2340.00

Pass Thru Towers can be special ordered with 100 taps...or more!

Irish Coffin Boxes

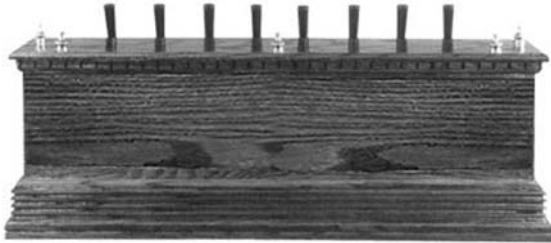

#8568-82

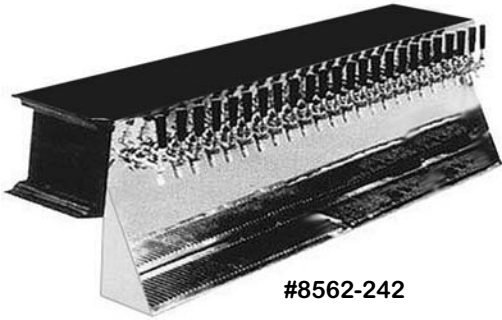

#8562-242

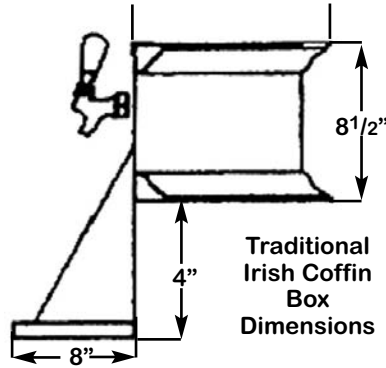

Traditional Irish Coffin Box Dimensions

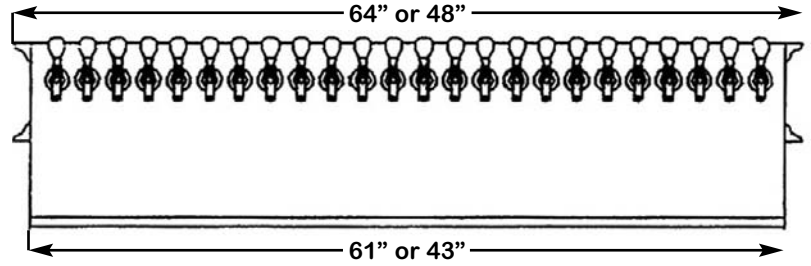

Traditional Irish Coffin Box is hand crafted in your choice of oak or mahogany. The box is placed directly on top of the bar, stainless steel drain assembly hangs below bar top. Available in three box widths, custom engraving available. **Classic Irish Coffin Box** is 3 1/2" taller than the Traditional box, providing a larger area for custom engraving and is available in one box width only.

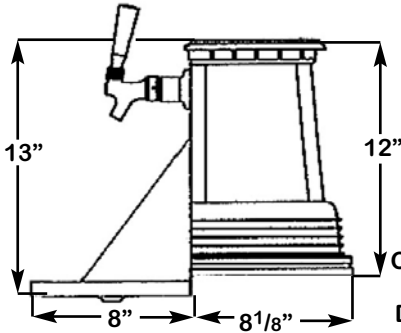

Classic Irish Coffin Box Dimensions



9 1/4"

Traditional Irish Coffin Boxes, 64" Box Width

Model#*	Description	Air Cooled	Glycol
8562-16	16 taps	\$2600.00	\$2825.00
8562-17	17 taps	2630.00	2855.00
8562-18	18 taps	2660.00	2885.00
8562-19	19 taps	2690.00	2915.00
8562-20	20 taps	2720.00	2945.00
8562-21	21 taps	2750.00	2975.00
8562-22	22 taps	2780.00	3005.00
8562-23	23 taps	2810.00	3035.00
8562-24	24 taps	2840.00	3065.00

Traditional Irish Coffin Boxes, 48" Box Width

8561-12	12 taps	2070.00	2270.00
8561-13	13 taps	2100.00	2300.00
8561-14	14 taps	2130.00	2330.00
8561-15	15 taps	2160.00	2360.00
8561-16	16 taps	2190.00	2390.00
8561-17	17 taps	2220.00	2420.00
8561-18	18 taps	2250.00	2450.00

Traditional Irish Coffin Boxes, 36" Box Width

8565-6	6 taps	1335.00	1510.00
8565-7	7 taps	1365.00	1540.00
8565-8	8 taps	1395.00	1570.00
8565-9	9 taps	1425.00	1600.00
8565-10	10 taps	1455.00	1630.00
8565-11	11 taps	1485.00	1660.00
8565-12	12 taps	1515.00	1690.00

*Add suffix for choice of wood: "-1" for Oak, "-2" for Mahogany (eg. 8561-12-2 is a 48" wide traditional box with 12 taps and mahogany construction)

Classic Irish Coffin Boxes, 36" Box Width

Model#*	Description	Air Cooled	Glycol
8568-5	5 taps	\$1565.00	\$1740.00
8568-6	6 taps	1595.00	1770.00
8568-7	7 taps	1625.00	1800.00
8568-8	8 taps	1655.00	1830.00
8568-9	9 taps	1685.00	1860.00
8568-10	10 taps	1715.00	1920.00
8568-11	11 taps	1745.00	1920.00
8568-12	12 taps	1775.00	1950.00

*Add suffix for choice of wood: "-1" for Oak, "-2" for Mahogany (eg. 8568-6-1 is a 36" wide classic box with 6 taps and oak construction)



Goliath Towers

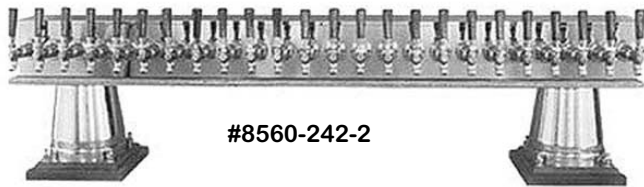

#8560-242-2



#8560-243-3

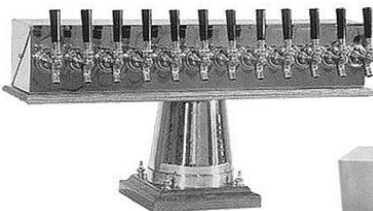

#8530W-122-2



#8530W-102-1

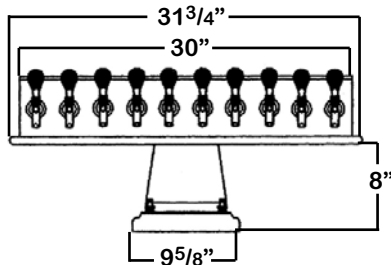

Lead Time
Allow 10-15 days from order date

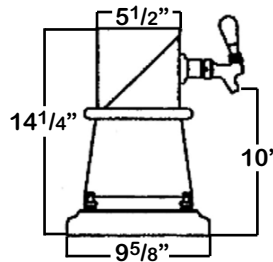

Goliath towers offer a choice of brass or chrome finishes on a beautiful hardwood base. **Standard Goliath Towers** are pass-thru type and can be ordered with up to 24 taps on a 60" box. **Goliath Junior Towers** are "T" type and come with up to 12 taps on a 30" box. Hardwood base available in Dark Oak, Light Oak or Black. Tops and backs of all towers are easily removable for servicing.

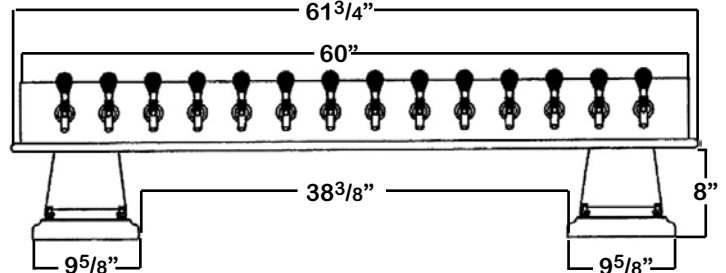

Standard Goliath Pass-Thru Towers

Model#*	Description	Air Cooled	Glycol
8560-102	10 tap brass	\$2160.00	\$2385.00
8560-103	10 tap chrome	2400.00	2625.00
8560-112	11 tap brass	2190.00	2415.00
8560-113	11 tap chrome	2430.00	2655.00
8560-122	12 tap brass	2220.00	2445.00
8560-123	12 tap chrome	2460.00	2685.00
8560-132	13 tap brass	2250.00	2475.00
8560-133	13 tap chrome	2490.00	2715.00
8560-142	14 tap brass	2280.00	2505.00
8560-143	14 tap chrome	2520.00	2745.00
8560-152	15 tap brass	2310.00	2535.00
8560-153	15 tap chrome	2550.00	2775.00
8560-162	16 tap brass	2340.00	2565.00
8560-163	16 tap chrome	2580.00	2805.00
8560-172	17 tap brass	2370.00	2595.00
8560-173	17 tap chrome	2610.00	2835.00
8560-182	18 tap brass	2400.00	2625.00
8560-183	18 tap chrome	2640.00	2865.00
8560-192	19 tap brass	2430.00	2655.00
8560-193	19 tap chrome	2670.00	2895.00
8560-202	20 tap brass	2460.00	2685.00
8560-203	20 tap chrome	2700.00	2925.00
8560-212	21 tap brass	2490.00	2715.00
8560-213	21 tap chrome	2730.00	2955.00
8560-222	22 tap brass	2520.00	2745.00
8560-223	22 tap chrome	2760.00	2985.00
8560-232	23 tap brass	2550.00	2775.00
8560-233	23 tap chrome	2790.00	3015.00
8560-242	24 tap brass	2580.00	2805.00
8560-243	24 tap chrome	2820.00	3045.00

*Add suffix to choose wood finish: "-1" for Dark Oak, "-2" for Light Oak, "-3" for Black (eg. 8560-202-1 is a 20 tap brass pass-thru tower with dark oak wood base)

Goliath Junior "T" Towers			
Model#*	Description	Air Cooled	Glycol
8530W-62	6 tap brass	\$1275.00	\$1400.00
8530W-63	6 tap chrome	1380.00	1505.00
8530W-72	7 tap brass	1305.00	1435.00
8530W-73	7 tap chrome	1410.00	1540.00
8530W-82	8 tap brass	1335.00	1470.00
8530W-83	8 tap chrome	1440.00	1575.00
8530W-92	9 tap brass	1365.00	1505.00
8530W-93	9 tap chrome	1470.00	1610.00
8530W-102	10 tap brass	1395.00	1540.00
8530W-103	10 tap chrome	1500.00	1645.00
8530W-112	11 tap brass	1425.00	1575.00
8530W-113	11 tap chrome	1530.00	1680.00
8530W-122	12 tap brass	1455.00	1630.00
8530W-123	12 tap chrome	1560.00	1715.00

*Add suffix to choose wood finish: "-1" for Dark Oak, "-2" for Light Oak, "-3" for Black (eg. 8530W-103-3 is a 10 tap chrome tower with a black base)

Wow! Mix 'N' Match to Create Your Own Unique Classic Black Tower!

Build with different components. Make an all-black tower, or combine different components for a Black and Chrome or a Black and Brass look. Caps, columns, flanges and faucets available in brass, chrome or black*.

Call for More Information

*faucet coupling nuts and tower spacing sleeves not available in black finish

Quick Chill Sexy Towers With Lighted Badges

Quick Chill Sexy Towers feature all metal Chrome or Gold Tone body. Chrome include Sanitary S/S Faucets with polished chrome finish. Gold Tone include Sanitary S/S faucets with tarnish free brass finish. Black faucet handles not included. Offered glycol cooled or flooded to put a coat of ice on the outside of the tower. Illuminated medallions come as shown with white badges. Brand I.D. badges are available from the beer wholesaler. All models include restriction balancing kit. FOB WI

Glycol & Ice Sexy illuminated Towers and Drip Pans for Lucky, Panther & Sexy Towers



#Taps	Description	Part #	Description	Price
3	Sexy Chrome	SY-3BIM	Glycol cooled	\$760.00
3	Sexy Gold	SY-F-3BGDIM	Glycol cooled	790.00
3	Sexy Chrome	SY-F-3BIM	Flooded-Iced	775.00
NA	S/S Drip Tray	43839SS	16" x 16"	170.00
NA	Gold Drip Tray	43839G	16" x 16"	205.00
NA	S/S Drip Tray	43840SS	16" x 23-1/4"	210.00
NA	Gold Drip Tray	43840G	16" x 23-1/4"	245.00

*Note: In order to build a layer of ice on the exterior of a tower an additional power pack is required, located as near as possible to the tower. Also for ice to form certain levels of humidity, temperature and virtually no convection (a lack of air movement) will be needed.

European Belgian Style Modular Towers

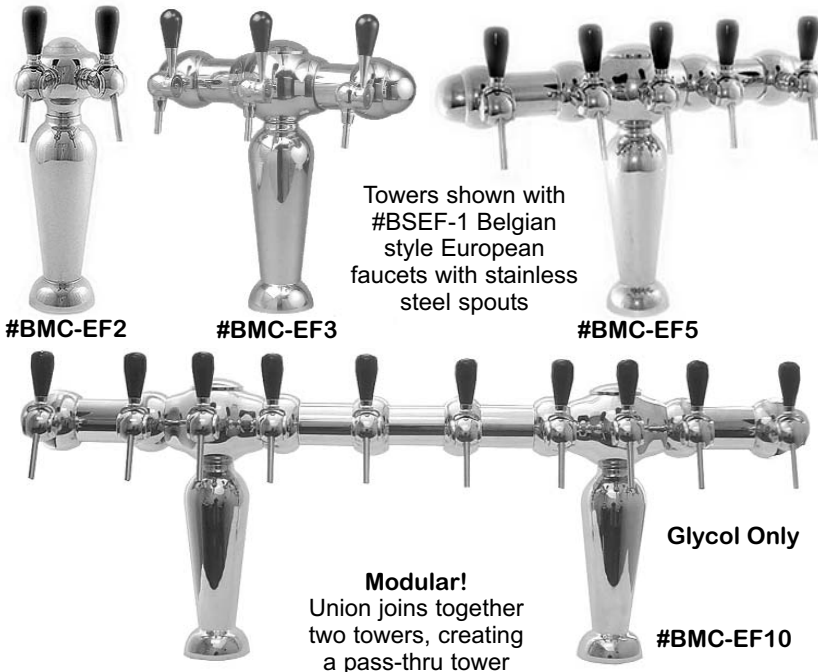

Towers shown with #BSEF-1 Belgian style European faucets with stainless steel spouts

Glycol Only

Modular!
Union joins together two towers, creating a pass-thru tower

Belgian Style Towers with sleek design and heavy cast components

- ✓ Available with European or US faucets. European faucets accept US tap markers. Flow control available at additional cost.
- ✓ 4" diameter base
- ✓ Approximate overall height 18 1/2" (with handle).
- ✓ Works well with straight drain trays (often featured with glass washers). See Page 80.
- ✓ 3/8" copper heat exchanger.
- ✓ European style faucets have about 3 feet of 5/16" OD stainless steel beer product tubing (a Tecflo flow control device or foam control faucets can be used to balance restriction).
- ✓ US faucets have 6 feet of 3/16" vinyl tubing for beer product line for each faucet.

#Taps	Overall Width	Center to Center*	Glycol-Ready Belgian-Style		Glycol-Ready U.S.	
			European Faucets	Cost	Faucets	Cost
2	5 3/4"	5 1/4"	BMC-EF2	\$1145.00	BMC-AF2	\$995.00
3	18"	13"	BMC-EF3	1395.00	BMC-AF3	1010.00
4**	24"	19"	BMC-EF4	1490.00	BMC-AF4	1140.00
5	24"	19"	BMC-EF5	1695.00	BMC-AF5	1220.00
10	51"	48"	BMC-EF10	3155.00	BMC-AF10	2455.00



#BSEF-1C Belgian Style faucets standard. Less expensive flow control (or US) faucets may be substituted at lower cost.

*measurement from one outside faucet to the other outside faucet
**4 tap towers look the same as 5 tap towers without the center tap



Lead Time
Chrome towers with US or European faucets: allow 3-6 work days. Special Order Brass towers (same cost as chrome towers): allow 5-6 weeks

Quick Chill European Style Towers



Quick Chill Lucky and Panther Towers feature all metal Chrome or Gold Tone body. Chrome include Sanitary S/S Faucets with polished chrome finish and black plastic spout. Gold Tone include Sanitary S/S faucets with tarnish free brass finish and black plastic spouts. Black faucet handles not included. Glycol models have S/S cooling loops. All models feature restriction balancing kit.

#LT-2 Lucky Two Tap Tower sold with optional tray. Faucet Height 13". Overall Height 16¹/₁₆"

Lucky and Panther Towers

#Taps	Description	Glycol Cooled	Air Cooled	Iced Style
1	Lucky Chrome	LT-1B \$395.00	3890-1B \$420.00	LT-F-1B* \$457.00
1	Lucky Gold	LT-1BDG 395.00	3890GD-1B 420.00	N/A
2	Lucky Chrome	LT-2B 495.00	3890-2B 565.00	LT-F-2B* 557.00
2	Lucky Gold	LT-2BDG 495.00	3890GD-2B 565.00	N/A
3	Panther Chrome	PT-3B 730.00	3895-3B 800.00	PT-F-3B* 792.00
3	Panther Gold	PT-3BDG 730.00	3895GD-3B 800.00	N/A
4	Panther Chrome	PT-4B 835.00	3895-4B 930.00	PT-F-4B* 882.00
4	Panther Gold	PT-2BDG 835.00	3895GD-4B 930.00	N/A

*Note: In order to build a layer of ice on the exterior of a tower an additional power pack is required, located as near as possible to the tower. Also for ice to form certain levels of humidity, temperature and virtually no convection (a lack of air movement) will be needed.



#PT-3 Panther Three Tap Tower sold with optional tray. Faucet Height 13". Overall height 15³/₄"

Drip Pans For Lucky and Panther Towers

Part#	Type & Size	Cost
43839SS	S/S 16"x16"	\$174.00
43839G	Gold 16"x16"	236.00
43840SS	S/S 16"x23 ¹ / ₄ "	241.00
43840G	Gold 16"x23 ¹ / ₄ "	288.00

QUICK CHILL



Quick Chill Exclusive!!!
Air Recirculation Kit.
Ideal for mounting Lucky and Panther Towers to a Direct Draw Box. Patent Pending

Panther Line Drawings

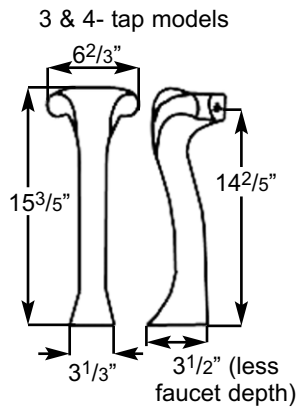

Base of Lucky and Panther Towers

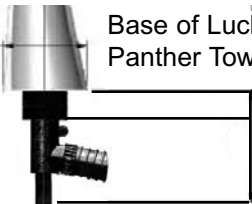

1 1/2" hollow threaded bolt is 2.14" long

4.53" from tower base to bottom of S/S barbed fittings

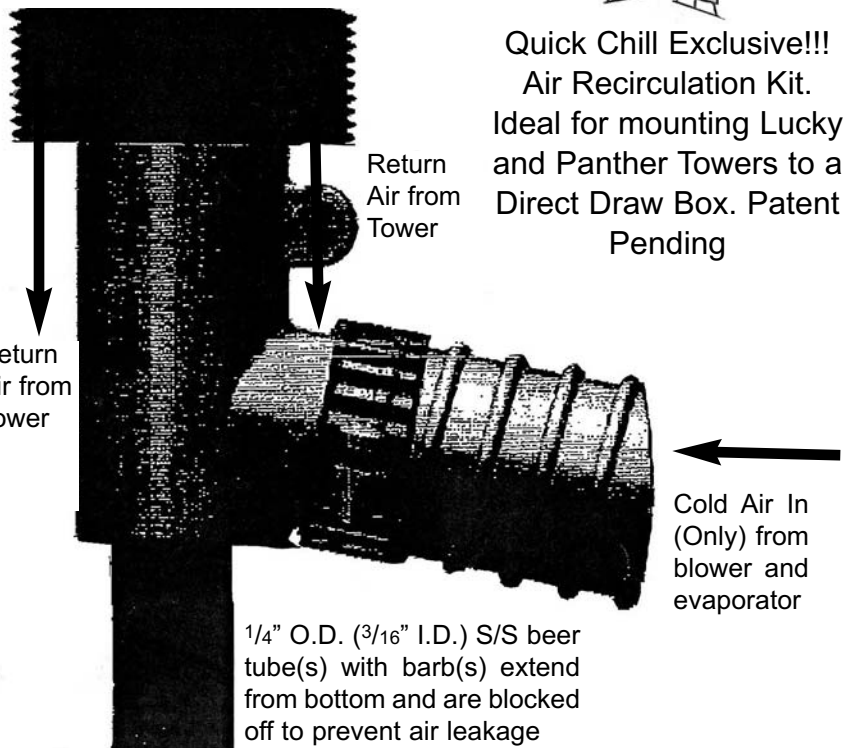

Lead Time Allow 3-6 work days to ship. F.O.B Factory WI

Drip Trays and Accessories

Countertop and Flanged Mount Drip Trays

NEW!
Now with
PVD Brass



Countertop drip trays mount on surface

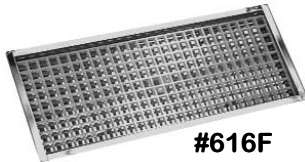

Flanged mount drip trays set into countertop for flush mounting

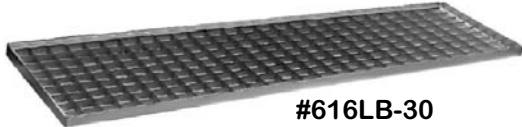

#616LB-30

Metal Replacement Grids

May be ordered with new tray or as replacement part. Special order sizes available



#GSS-145

White and Black Plastic Replacement Grids

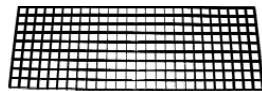

#BEC-508

White plastic standard with S/S trays, black plastic standard with brass trays listed above. Special order sizes available

Part#	Type Metal	Drain Width	Cost
GSS-85	S/S	8 1/8"	\$16.15
GBR-85	PVD Brass	8 1/8"	25.50
GSS-145	S/S	14 7/8"	21.25
GBR-145	PVD Brass	14 7/8"	33.15
GSS-245	S/S	23 7/8"	28.05
GBR-245	PVD Brass	23 7/8"	45.90
GSS-305	S/S	30 1/4"	33.60
GBR-305	PVD Brass	30 1/4"	56.00
GSS-365	S/S	35 7/8"	41.60
GBR-365	PVD Brass	35 7/8"	72.80

Part#	Type Plastic	Drain Width	Cost
WEC-508	White	8 1/8"	\$7.95
BEC-508	Black	8 1/8"	10.95
WEC-515	White	14 7/8"	8.95
BEC-515	Black	14 7/8"	11.95
WEC-524	White	23 7/8"	9.95
BEC-524	Black	23 7/8"	13.95
WEC-530	White	30 1/4"	10.95
BEC-530	Black	30 1/4"	13.95
WEC-536	White	35 7/8"	11.95
BEC-536	Black	35 7/8"	15.95

Counter Top Drip Trays (mount on surface)

Dimensions W	D	H	Drain Fitting	S/S w/ White Plastic Grid		PVD Brass w/ Black Plastic Grid	
				Model#	Cost	Model#	Cost
8 1/8"	5 3/8"	3/4"	None	608	\$24.45	608B	\$45.45
8 1/8"	5 3/8"	3/4"	205P	609	29.45	609B	59.45
14 7/8"	5 3/8"	3/4"	None	615	30.45	615B	48.45
14 7/8"	5 3/8"	3/4"	205P	616	35.65	616B	65.85
23 7/8"	5 3/8"	3/4"	None	615L	35.15	615LB	61.75
23 7/8"	5 3/8"	3/4"	205P	616L	42.45	616LB	86.25
30 1/4"	5 3/8"	3/4"	None	615L-30	45.85	615LB-30	74.85
30 1/4"	5 3/8"	3/4"	205P	616L-30	58.00	616LB-30	86.75
35 7/8"	5 3/8"	3/4"	None	615L-36	63.75	615LB-36	112.75
36 1/4"	5 3/8"	3/4"	205P	616L-36	68.75	616LB-36	120.75

Flanged Mount Drip Trays (set into countertop)

Dimensions W	D	H	Drain Fitting	Model#	Cost	Model#	Cost
8 1/8"	5 3/8"	3/4"	205P	609F	37.65	609FB	65.20
14 7/8"	5 3/8"	3/4"	205P	616F	44.45	616FB	74.55
23 7/8"	5 3/8"	3/4"	205P	616FL	49.95	616FLB	86.25
30 1/4"	5 3/8"	3/4"	205P	616FL-30	62.75	616FLB-30	91.65
36 1/4"	5 3/8"	3/4"	205P	616FL-36	67.85	616FLB-36	119.95

Flanged mount drip trays may be ordered without drain fittings. Call for pricing. *Flanged mounts "W" and "D" dimensions are the cut-out size. Flange is an additional 3/8".

Deluxe Mushroom Drip Trays

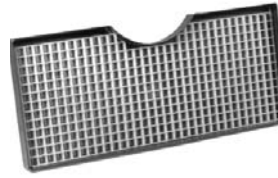

#MDT-19S Stainless steel with white plastic grid.....\$88.95

#MDT-19B PVD Brass with black plastic grid.....\$123.95

Metal Replacement Splash Grids

Fit Mushroom Drain Trays

Part#	Metal	Cost
GSS-MDT	S/S	\$72.50
GBR-MDT	PVD Brass	91.50

19"W x 8 1/8"D x 1"H with 7.56" diameter cut-out for tower clearance. Drain fitting 205P.

Plastic Drip Tray

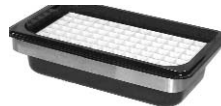

#1525NS

High impact black plastic molded tray, 10 3/8"W x 6 1/4"D x 2 1/8"H. S/S mounting bracket, plastic splash grid (screws not included)

1-5	6-UP
\$11.95	\$9.95



Lead Time

Almost all items featured on this page are in our stock or manufacturer's stock for immediate shipment.



#DBK-1 Drain Bottle Kit For use with any 1/2" M.P.T. drain. 1 qt. drain bottle collects drippings. Includes clamp to secure hose.

1-5	6-UP
\$10.50	\$9.25

Accessories



#205P-2 Plastic drain pipe, 1/2" M.P.T. x 2" long with gasket and lock nut. \$12.95



#205B-L4 Brass drain fitting, 1/2" M.P.T. x 4" long with gasket and lock nut. \$11.95

#205B-L6 Same as above but 6" long. \$15.95



#CAPSS-10 Clear Silicone Sealant. 10 oz. caulk tube. \$5.95



#205-151A Plastic 45° angle adapter. 1/2" F.P.T. fits 205P or 205-150A. 1/2" nipple will fit 604 1/2" hose. \$3.95



#205P-LW Leather lock washer \$3.75



#205-150A Male thread often used with #205-151A in Beverage-Air direct draw cabinets, drains and blower housings. 1/2" M.P.T. x 1/2" long. \$3.95



#205P-LN Lock nut for #205P \$3.75



#205P-RW Rubber lock washer for 1/2" M.P.T. drain pipe \$.95



#205S Plastic straight hose barb adapter, 1/2" F.P.T. x 1/2" hose barb \$6.95



#PVC-205S Black plastic straight hose barb adapter, 1/2" F.P.T. x 1/2" hose barb \$4.25

Need a Special Drain Fitting? Call with Dimensions and We Will Run It Down For You!



Drain Nipple Replacements for Many Surface Mount Series

Part#	Length	Cost
TDN-3	3 1/2"	\$14.95
TDN-6	6"	17.95
TDN-8	8"	21.95

Drip Trays



Recessed - Flush Mount Drip Trays

All 3/4" deep, includes 4" long x 1/2" O.D. centered drain nipple

Dimensions	S/S	Cost	Tarnish-Free Brass	Cost
7 ⁵ / ₈ "x8 ³ / ₄ "	C11988A	\$79.00	C11988ATF	\$179.00
7 ⁵ / ₈ "x14 ¹³ / ₁₆ "	C21379A	94.00	C21379ATF	194.00
7 ⁵ / ₈ "x20 ⁵ / ₈ "	C32257	105.00	C32275TF	247.00
5 ¹ / ₈ "x18 ¹³ / ₁₆ "	C32357	103.00	C32357TF	210.00
5 ¹ / ₈ "x37 ⁵ / ₁₆ "	58979	136.00	58979TF	315.00



4-7/8" Surface Mount Drip Trays

All 3/4" deep, includes 4" long x 1/2" O.D. centered drain nipple

Dimensions	S/S	Cost	Tarnish-Free Brass	Cost
4 ⁷ / ₈ "x5 ³ / ₈ "	5015	85.00	5015TF	147.00
4 ⁷ / ₈ "x13 ³ / ₄ "	5020	89.00	5020TF	158.00
4 ⁷ / ₈ "x19"	5025	94.00	5025TF	168.00
4 ⁷ / ₈ "x24"	5028	99.00	5028TF	205.00
4 ⁷ / ₈ "x37"	5030	129.00	5030TF	310.00

New! 7-7/8" Surface Mount Drip Trays

All 3/4" deep, includes 4" long x 1/2" O.D. centered drain nipple

Dimensions	S/S	Cost	Tarnish-Free Brass	Cost
7 ³ / ₈ "x8 ³ / ₄ "	C18635A	89.00	C18635ATF	149.00
7 ³ / ₈ "x14 ¹³ / ₁₆ "	C18640A	90.00	C18640ATF	159.00
7 ³ / ₈ "x20 ³ / ₄ "	C18645A	95.00	C18645ATF	168.00
7 ³ / ₈ "x26 ³ / ₄ "	C18650A	100.00	C18650ATF	209.00
7 ³ / ₈ "x33"	C18655	131.00	C18655TF	309.00
7 ³ / ₈ "x49"	C18660	169.00	N/A	

Angled Drain Trays



Angled trays have white plastic grid. 4" long 1/2" NPT drain fitting included. Great for Mushrooms, Ceramic Towers, round countertop or corner installations. We'll supply a drawing upon request.

Part#	Description	Dimensions	Cost
57120-PK	Stainless Steel	9"x20 ¹ / ₄ "	\$177.00
57120TF-PK	Tarnish-Free Polished Brass	9"x20 ¹ / ₄ "	259.00

Cut-Out Drain Trays

Cutout Style Surface Mount Drip Trays

All 3/4" high, metal grid w/round holes and a 3 1/2" drain

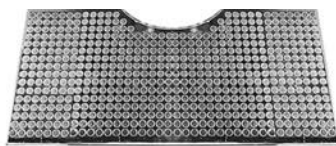

#CT-1611S

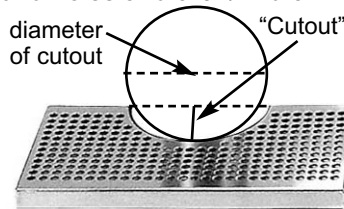

#CT-1611S

Model#	Finish	Dimensions W D	Diam. x Cutout	Recommended For Which Towers	Cost
CT-127B	TF Brass	12" 7"	5" x 2"	1-3 tap 3" diam. column	\$186.00
CT-127S	S/S	12" 7"	5" x 2"	w/ 4 1/2" base flange	135.00
CT-189B	TF Brass	18" 9"	6 1/4" x 2"	4-5 tap mini mushroom	220.00
CT-189S	S/S	18" 9"	6 1/4" x 2"	w/ 5 3/4" base flange	160.00
62303	Brass	19 3/4" 10"	8 5/8" x 3 1/2"	Roma 8 1/2" base flange	195.00
62303SS	S/S	19 3/4" 10"	8 5/8" x 3 1/2"	Roma-8 1/2" base flange	250.00
62304	Brass	19 3/4" 10"	10 1/8" x 3 1/2"	Torino 10" base flange	250.00
CT-2411B	TF Brass	24" 11"	8" x 3 1/2"	Deluxe Mushroom	270.00
CT-2411S	S/S	24" 11"	8" x 3 1/2"	Deluxe Mushroom	290.00

Dimensions are approximate-we will supply a drawing on request.

Laser Cut Drip Trays



Countertop Models

#LCDT24-S

Model#	Dimensions			Cost
	W	D	H	
LCDT8-S	8"	5 1/4"	3/4"	\$56.50
LCDT15-S	15"	5 1/4"	3/4"	61.50
LCDT24-S	24"	5 1/4"	3/4"	71.50
LCDT30-S	30"	5 1/4"	3/4"	91.50
LCDT36-S	36"	5 1/4"	3/4"	102.50
LCDT48-S	48"	5 1/4"	3/4"	122.50

Flush Mount Models

Model#	Dimensions			Cost
	W	D*	H	
FMDT15-S	15"	5 1/4"	3/4"	\$72.50
FMDT24-S	24"	5 1/4"	3/4"	92.50

Not shown.*All flush mount models have a 1/2" flange that is not included in the dimensions above

If you don't see it we still may be able to get it or make it! Other models and special order trays available!

Stainless Steel Straight Drain Trays with Glass Washers



Drain trays with glass washers flash chill and rinse glasses and promote better quality pour with less foam, as the temperature of the glasses are closer to the beer temperature. Value is enhanced as the glass is colder. Product has a better taste, as sanitizing chemicals are rinsed off. Eye-pleasing presentation promotes more beer sales ...and more profits!

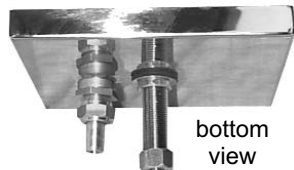
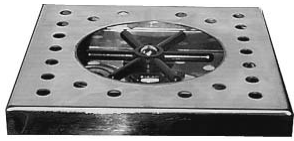

bottom view
drain pipe
water inlet



#DTGWS-88



#BB101174-15



New!

8" x 8" drain with 8" x 4 1/2" mounting plate
9 screw holes (wood screws included)

#DTGWS-88CM

Glass washer features 6 legged push-down arms with fine spray nozzles. Handles glasses up to 4" in outside diameter. S/S drip trays with S/S grids, all 3/4" high with 2" x 1/2" MPT brass drain pipe. Water inlet has a female 3/8" John Guest inlet receptacle, which can be substituted for a beer hex nut and nipple. Pricing does NOT include 3/8" barbed John Guest inlet hose fitting. Operates on standard water pressure of 40 - 50 lbs. Water regulator and water shut-off are recommended.

Model#	Width	Depth	Cost
DTGWS-88	8"	8"	\$120.00
DTGWS-88CM*	8"	8"	165.00
DTGWS-107	10"	7"	135.00
DTGWS-157	15"	7"	146.00
DTGWS0247	24"	7"	160.00
DTGWS-307	30"	7"	174.00
DTGWS-367	36"	7"	200.00
DTGWS-457	45"	7"	245.00

*with 8" x 4 1/2" mounting plate

Glass Washer Drain Trays with Tower Mount Drip Pan

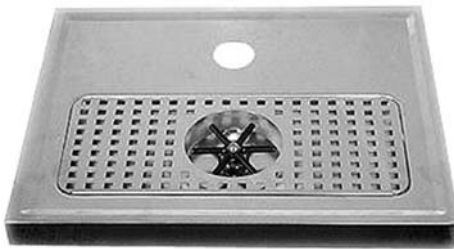

Shown with optional hole for tower mounting (can be ordered with or without pre-drilled tower mounting hole, please specify when ordering)

Model#	Overall Width	Overall Depth	Cost
DTGWS-2015	19 1/2"	15 1/2"	\$240.00
DTGWS-2816	27 1/2"	15 1/2"	280.00



Lead Time

Stainless Steel drain trays with stainless steel grids and glass washers: allow 3-6 work days. Available in brass at additional cost, allow 5-6 weeks.

Custom Wall Mount, Surface Mount, Flange Mount, Bar Rail & Underbar Mount Drain Trays Made to Your Specification. Call for a quote today!

Bar Rail Style Drip Trays



Specifically made for 4" cylinder towers, mini-mushroom towers, sports towers, etc. 17"W x 15"D overall. Drain pan is 8" deep. 3" x 1" M.P.T. drain outlet. Chrome plated or brass plated plastic splash grid. Many more styles

available or can be special ordered, please call with your needs.

#1492S	Stainless steel, 17" x 15" OA.....	\$155.95
#1492B	Brass, 17" x 15" OA.....	\$155.95
For deluxe mushroom towers, 19"W x 17"D overall. Drain pan is 8" deep. 1" NPT diameter drain pipe. Chrome plated or brass plated plastic splash grid		
#1493S	Stainless steel, 19" x 17" OA.....	\$165.95
#1493B	Brass, 19" x 17" OA.....	\$165.95
#1492SS	S/S w S/S grid 17" x 15" OA.....	\$195.95
#1492BB	Brass w brass grid 17" x 15" OA.....	\$205.95
For Deluxe Mushroom Towers		
#1493SS	S/S with S/S grid, 22" wide.....	\$350.95
#1493BB	Brass with Brass Grid, 22" Wide.....	\$305.95

Stainless Steel Drip Trays



#DT-24S

Stainless steel drip pans feature stainless steel splash grids and 2" x 1/2" male pipe thread centered brass drains. All 5 3/8" deep and 3/4" high.

Model#	Description	Cost
DT-10S	10 1/4" long w/brass drain	\$67.00
DT-10S-ND	10 1/4" long, no drain	65.00
DT-15S	14 7/8" long w/brass drain	77.00
DT-15S-ND	14 7/8" long, no drain	75.00
DT-24S	23 7/8" long w/brass drain	99.00
DT-24S-ND	23 7/8" long, no drain	97.00
DT-30S	30 1/4" long w/brass drain	113.00
DT-36S	36 1/4" long w/brass drain	124.00
DT-45S	45 1/4" long w/brass drain	145.00

New! Craft Meister Alkaline Brewery Wash-Great For Cleaning Stainless Steel, Plastic or Glass

Home Brewing Equipment

BTF Iadofor Sanitizer

Great for sanitizing beer lines-inside and out. A Homebrewer's favorite for sanitizing anything that contacts beer. Sanitizes ice machines after cleaning with nickel safe DBC Cleaner.



#CBW-1 Craft Meister Brewery Wash. 1 lbs. Jar of Powder.
1-5 \$6.05 6-UP \$5.45



#CBW-3 Craft Meister Brewery Wash. 3 lbs. Container of Powder
1-5 \$13.95 6-UP \$12.55



Washes brew kettles, corny kegs, fermentors, fobs, and bottles. Quick dissolving powder removes beer residues in hot or cold water

#CBW-40 Craft Meister Brewery Wash. 40 lbs. Pail of Powder
1-5 \$78.95 6-UP \$74.55



#CBW-5 Craft Meister Brewery Wash. 5 lbs. Pail of Powder
1-5 \$22.40 6-UP \$19.05



#BTF-32

B*T*F Liquid Iadofor Sanitizer in 32 oz. Bottle



B*T*F Liquid Iadofor Sanitizer in 4 oz. Bottle

#BTF-04

1-5 \$2.55 6-UP \$2.45

1-5 \$9.75 6-11 \$9.45 12-UP \$8.95



All kits assembled and include:
✓Reconditioned 5 lb. tank
✓Double gauge regulator with shut-off
✓CO2 line, clamps
✓Disconnects, 4 ft. of tubing and plastic faucet
✓Reconditioned 5 gallon tank

#HBK-1 For use with Canister set-up. Includes reconditioned 5 gallon S/S tank and ball lock style disconnects (Pin lock available as special order)
1-7 \$144.95 8-UP \$134.95

#HBK-1-LFGT Same as #HBK-1 but without S/S 5 gallon product canister.
1-7 \$114.95 8-UP \$104.95



Reconditioned Five Gallon Ball Lock Tank With New Lid #RC-5BL

All Stainless Steel tank with bonded rubber bottom. Stainless steel cover with relief valve, stainless steel siphon tube, about 25" high x 8 1/2" diameter.

1-7 \$43.95 8-UP \$39.95

Kits available without 5 lb. CO2 tank. Call for pricing.

Universal Five Gallon Keg Gasket Sets

Include one #536082 "O" ring, two #180363 "O" rings and two #854201 "O" ring ball lock style OR #854501 "O" ring pin lock style
#BALGS-1 Ball Lock Gasket Set

1-5 \$4.45 6-UP \$3.45

#PILGS-1 Pin Lock Gasket Set

1-5 \$4.45 6-UP \$3.45

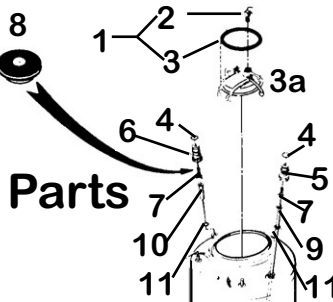

Parts

No.	Part#	Description	1-9	10-UP
1	180777	Cover assembly, S/S w/relief valve (includes #2 & #3)	\$22.95	\$20.95
2	180353-888	Relief valve	12.75	11.75
3	536082	Lid "O" ring	2.95	1.95
3	OS-536082	Oversize "O" ring	4.95	2.95
4	854201	"O" ring (ball lock)	.68	.51
4	854501	"O" ring (pin lock)	.68	.51
5	180210	Connector body liquid (ball lock)	19.95	18.95
5	180592	Connector body liquid (two-pin)	31.95	29.95
6	180211	Connector body gas (ball lock)	19.95	18.95
6	180593	Connector body gas (three-pin)	31.95	29.95
7	180371-013	Valve poppet assembly (incl. #8)	6.95	5.95
8	180018-013	Seal, poppet valve	1.95	1.75
9	180412	Siphon tube	9.95	8.95
10	180426	Gas tube	2.95	2.55
11	180363	"O" ring	.68	.51

Parts listed are for Super Champion soft drink tanks manufactured by Cornelius and may NOT be compatible with tanks of other manufacturers. Availability may vary as this tank line may be discontinued by manufacturer. Other parts available, please call us with the serial number and manufacturer of your tank.

Accessories

Quick Disconnects

Ball Lock Style Fits standard product tanks, Pepsi, 7-Up and more.

#27-4242 Gas Disconnect with 1/4" barb fitting
1-9 \$6.25 10-UP \$4.55

#27-4244 Gas Disconnect with 1/4" male flare fitting
1-9 \$6.25 10-UP \$4.55

#27-4243 Liquid Disconnect with 1/4" barb fitting
1-9 \$6.25 10-UP \$4.55

#27-4245 Liquid Disconnect with 1/4" male flare fitting
1-9 \$6.25 10-UP \$4.55

Pin Lock Style Fits Coca-Cola product tanks
#720400 Gas Disconnect, 2 slot with 1/4" barb fitting
1-9 \$6.95 10-UP \$5.05

#720401 Liquid Disconnect, 3 slot with 1/4" barb fitting
1-9 \$6.95 10-UP \$5.05



#27-4242
#27-4243



#720400
#720401



#NP-SN-4
1/4" nut
\$.42



#NYFW-4
1/4" nylon washer
\$.12



#NS-764 In-line check valve. Brass with 5/16" - 3/8" barb fittings. Prevents backflow of CO2 or beer. Helps prevent cross-fertilization and regulator damage. \$6.95



#SS-SHS-44
1/4" stem
\$.52



#SS-SHSA-544
1/4" nut x 5/16" barbed stem
\$2.45

Thermometers, Tools & Testing Equipment



#30150 **#30150** 1" Dial Thermometer with pocket sheath and clip. Recalibratable in 2° increments. 0° to 220° F. range. NSF approved, accurate to +/- 1° F. **\$7.95**



#999 **#999** 5" Glass Stick Thermometer with pocket sheath and clip. Spirit filled in increments of 2° with a 0° to 220° F. range. **\$8.90**



#30301 Refrigerator/Freezer Dial Thermometer. Easy-to-read bold numbers and color coded temperature zones. -20° to +80° F. temperature range. S/S body for many years of service. Free standing or hang in unit. **\$4.75**



#WMTB-4-T220 Bottle and thermometer is 6 1/2" tall x 1 5/8" diameter. Just add water for refrigerator applications above 32 degrees (glycol is needed for conditions below 32 degrees). Once S/S probe is inserted thermometer probe is only exposed to the inside of the bottle. Seal is both liquid & air tight. Includes two mounting brackets. Thermometer is NSF approved and recalibratable. **\$9.95**



#25HP **#86-DT302** Digital Thermometer with pocket sheath and clip. -50° to + 392°F temperature range. Shatterproof. calibratable in 2° increments. 0° to 220° F. range. NSF approved, accurate to +/- 1° F. Battery and instructions included

\$15.95



#DTGK-1 Drop-Test Gauge Kit

For use on outlet fitting of air cock or nipples of regulator to test accuracy of primary/secondary gauge read-out or to pre-set gaugeless regulators..... **\$39.95**



#4136 Heavy duty tower wrench. Fits 1 1/16" opening. **\$24.95**



#DSTW-1 Heavy duty double sided tower wrench. Made of 1/4" thick hardened steel. Fits 1" and 1 1/16" lock nuts **\$25.95**



#4135 One sided tower wrench. Fits 1" to 1 1/16" nuts. **\$24.95**



Set of 3 extra-thin wrenches for repairing draft towers. **#DTW-SET** 1 1/16", 3/4" and 9/16" wrenches **\$79.95**



#4134 Heavy duty tower wrench. Made of thick hardened steel. **\$36.95**



#32700A Test Kit Includes **#261596** Test coupler attains a keg's temperature, pressure and the accuracy of a regulator gage. The complete kit can also test pressure balance & flow rate throughout the system and at the faucet. It can also test for taste and clarity. Please call for more information, specification sheet and directions. **#32700A TEST KIT \$369.95**

Heavy Duty Stainless Steel Cutting Hole Saws

Brazed carbide metal cutting saws work great on carbon steel, cast iron, stainless steel and aluminum. Not recommended for use with brass or wood. Must be used with slow speed drill (approximately 200 RPM for smaller diameters down to 60 RPM for larger diameters) and cutting oil for maximum effectiveness. 1" drilling depth standard.



#04Z-NRT Rapid Tap™ Cutting Fluid 4 oz. can **\$2.00**



#HS-48 Assembled 3" complete kit



#HS-16 1" complete kit, unassembled. Includes (from left to right): Allen key, pilot, hole saw and mandrel.

Diam.	Complete with Mandrel and Pilot		Hole Saw Only		Replacement Mandrels		Replacement Pilots	
	Part#	Cost	Part#	Cost	Part#	Cost	Part#	Cost
7/8"	HS-14	\$55.00	HS-14HO	\$38.00	S-12	\$11.00	SP-41	\$6.00
1"	HS-16	56.00	HS-16HO	39.00	HS-S4	11.00	SP-41	6.00
1 1/8"	HS-30	73.00	HS-30HO	56.00	HS-S4	11.00	SP-41	6.00
2"	HS-32	74.00	HS-32HO	56.00	HS-S6	11.00	SP-61	6.00
2 1/2"	HS-40	80.00	HS-40HO	63.00	HS-S6	11.00	SP-61	6.00
2 3/4"	HS-44	83.00	HS-44HO	66.00	HS-S6	11.00	SP-61	6.00
3"	HS-48	92.00	HS-48HO	75.00	HS-S6	11.00	SP-61	6.00
3 1/2"	HS-56	104.00	HS-56HO	87.00	HS-S6	11.00	SP-61	6.00
4"	HS-64	119.00	HS-64HO	102.00	HS-S6	11.00	SP-61	6.00



#261596 Test Coupler only- \$114.95 a key component of **#32700A** test kit



#DRILLGUIDE-1

Reamer drill guide for enlarging 3/16" ID shanks to 1/4" ID to enhance beer flow and lessen agitation. Used with standard 1/4" bit that has drawing tips filed down. Attaches to faucet coupling nut. Drill bit not included. **\$12.95**

Electric Beer Coil Cleaner



#ECC-100
\$899.95

Great For Long Distance Runs! Pump is powerful and pressure is adjustable. Equipped with sight glass & gauge.

Every cleaner is shipped complete with:

- ✓ One 6 ft. suction hose (equipped with strainer to prevent entry of foreign matter into pump)
- ✓ One 6 ft. pressure hose (equipped with slip coupling for attaching to beer faucet)
- ✓ One double male connector (for coupling beer lines)
- ✓ Four fiber washers (2 for connector, 1 each for hoses)
- ✓ Sponge kit (used in larger lines for more thorough cleaning)
- ✓ One set parts list and operating instructions

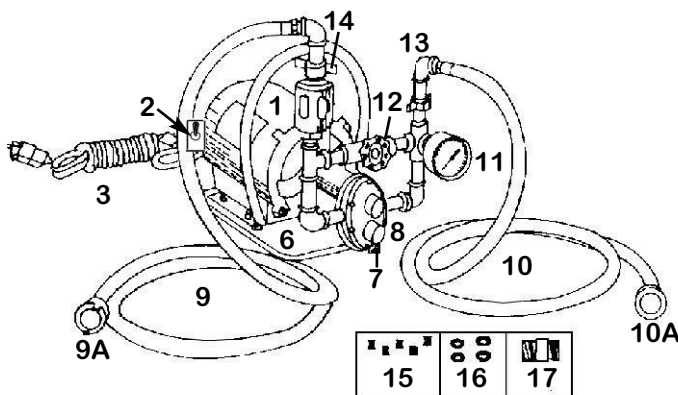

Each unit is tested and inspected before being packaged in a specially designed carton. Ship weight 31 lbs.

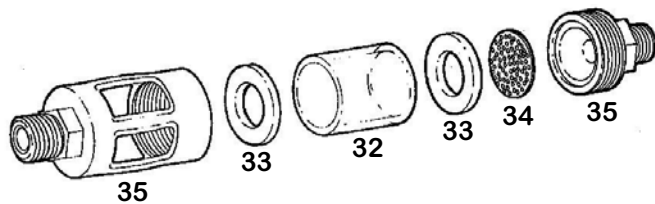
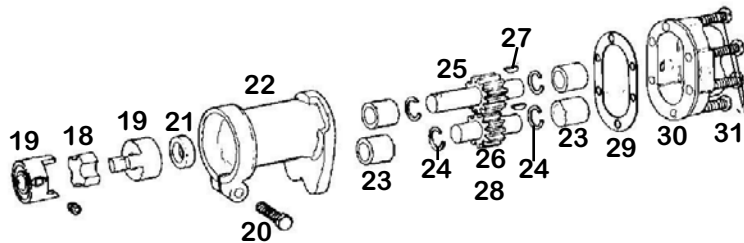

Sponges in Six Sizes



#104-110 Sponge Kit

Standard package shipped with #ECC-100 cleaner. Includes 5 each 1/8", 3/16", 1/4", 5/16" sponges **\$3.05**

Part#	Diam.	1-24	25-UP
104-112	1/8"	\$.35	\$.25
104-113	3/16"	.35	.25
104-114	1/4"	.35	.25
104-115	5/16"	.35	.25
104-116	3/8"	.35	.25
104-118	1/2"	.35	.25



Cleaning adapter for Belgium style and many other european faucets. All S/S with 3/8 barbed inlet. #EURO-CLEAN \$17.95

European cleaning adapter that can double as conversion shank, replaces European faucet and shank so US faucet cleaning fitting can be installed. **#IDEUR-CLEAN-1/2 1" long x 1/2" for BSEF Belgium style faucets \$15.95**

#IDEUR-CLEAN-7/8 2" long x 7/8" \$15.95

Cleaning Equipment

Major Visible Parts

No.	Part#	Description	Cost
1	104-1	Motor, 115V	\$154.50
2	104-1E	Switch (toggle type)	8.45
2	104-1E1	Switch Mounting Box	12.95
2	104-1E2	Switch Box Cover Plate	6.25
3	104-1B	Cord only	11.95
6	104-3	Aluminum Base	43.95
7	104-3A	Rubber Feet (each)	1.35
8	104-2	Pump(complete w/bronze gears)	275.75
8	104-2PPS	Pump(complete w/plastic gears)	250.95

Pump Parts

9	104-5C6S	6 ft. Suction Hose Only	15.95
9	104-5C8S	8 ft. Suction Hose Only	18.50
9	104-5C12S	12 ft. Suction Hose Only	22.50
9A	104-5B	Suction Strainer Ass'y	39.99
9A	104-5B1	Suction Strainer Fitting Body	18.99
9A	104-5B2	Suction Strainer Collar Nut	19.50
9A	104-5B3	Suction Strainer Screen	2.45
10	104-5C6P	6 ft. Pressure Hose Only	15.50
10	104-5C8P	8 ft. Pressure Hose Only	17.85
10	104-5C12P	12 ft. Pressure Hose Only	22.50
10A	4352T	Threaded Cleaning Attachment	13.75
11	104-7	Liquid Filled Pressure Gauge	20.75
12	104-6	By-Pass Valve	13.99
12	104-6H	By-Pass Valve Hand Wheel	3.50
13	104-2E	Pump to Motor Bracket	81.95
14	104-8	Handle	21.65
15	104-110	Sponge Kit	4.50
16	24R	Rubber Washers (each)	.18
17	SS-252	Double Male Connector	10.95

Brass Fittings (Not Shown)

N/A	104-31	3/8" x 1 1/2" Nipple	3.20
N/A	104-32	3/8" x 2" Nipple	2.95
N/A	104-33	3/8" Elbow	7.95
N/A	104-34	3/8" Tee	9.45
N/A	104-36	3/8" Flange Nipple	9.45

Pump Parts

18	104-2G	Spider	6.38
19	104-2F	Coupling (half)	14.75
20	104-2H	Screw	3.21
21	104-2B	Seal	15.75
N/A	104-SIT	Seal Installation Tool	21.95
22	104-2J	Cover Casting	95.95
23	104-2D	Carbon Bearings	14.95
24	104-2A1	Retaining Ring	6.50
N/A	104-2A1P	Retaining Ring Pliers	20.95
25	104-2A2	Drive Shaft only	18.50
26	104-2A3	Gear only (plastic)	39.95
27	104-2A4	Key	4.95
28	104-2A5	Idle Shaft	21.95
29	104-2C	Paper Gasket (older models)	1.65
29	104-2O	"O" Ring (newer models)	9.55
30	104-2K	Body Casting	69.95
31	104-2M	Screw (each)	2.95

Replacement Parts for Bronze Gears (Not Shown)

N/A	104-2AB1	Bronze drive gear ass'y	46.95
N/A	104-2AB2	Bronze idle gear ass'y	43.25

Replacement Parts for Plastic Gears

24, 25, 26, 27	#104-2AP1	Plastic drive gear ass'y	61.95
24, 26, 27, 28	#104-2AP2	Plastic idle gear ass'y	60.25

Sight Glass Assembly

32	104-4A	Pyrex Glass	8.15
33	104-4B	Gasket (each)	1.35
34	104-4C	Brass Screen	4.75
35	104-4D	Casting Set	52.50

Other parts available. If you don't see it, ask!

Beer Line Cleaning Equipment

If You Don't See It, Ask!

Little Giant Cleaning Kit

Can clean up to six beer lines at a bar. Recommended distance of 25 feet or less per line. Includes Components #1 through #8 below. Fully assembled with instructions.

#LG-KIT \$134.95



Component #1

#IP32 Little Giant Pump
Submersible, aluminum housing with epoxy coating. Nylon pumping head and impeller. Thermal overload protector. 1/15 HP motor pumps 185 gallons per hour at 6 ft. rise.

\$93.95



Component #3

#252 Duplex coupling, connects two lines or can be used with #132 beer "Y's" (page 73) to clean multiple lines.

1-5 \$9.50 6-UP \$8.95



Component #2

#604S Six ft. of 1/2" tubing (other lengths available) with #205P pump adapter and #254 straight cleaning attachment.

\$12.95



Component #4

#1350 Heavy duty faucet wrench with red rubber coated handle. Durable and easy to use.

1-5 \$2.95 6-11 \$2.75 12-UP \$2.45

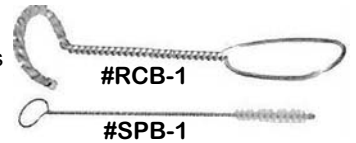

Components #5 & 6

Brush set insures a fine glass of beer. Round brush removes yeast and spillage from bottom threads of coupler. Small brush cleans tap.

#SPB-1 Small Probe Brush.....\$2.85
#RCB-1 Round Coupler Brush.....\$3.95



Components #7 & 8

#1329 Faucet Brush

1-11 \$2.05 12-99 \$1.85 100-UP \$1.65

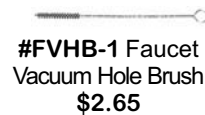

#FVHB-1 Faucet Vacuum Hole Brush
\$2.65

Great For Bars, Coil & Cold Plate Coolers, Home Kits and More!



Sankey One Piece Metal Flushers with SS Wire Ball Lifting Probes. Fits both US and European Sankey Couplers

#2W-FLUSH Double Flusher \$39.95

#1W-FLUSH Single Flusher x male beer threads \$33.95



#SERIES-FLUSH Single Sided Flusher without male beer threads \$26.95



#938-GH58 Water Pressure Cleaning Adapter

10' of 3/8" braided high pressure water line. One end equipped with garden hose connection and can hook to standard laundry faucet. Other end is female Sankey adapter and accepts any US Sankey coupler.

\$39.95



Cleaning Container Kits

Great for picnic pumps, cold plate and coil coolers, bars, beer trailers and more! Just fill with solution, tap coupler into container top as you would a keg, apply pump or CO2 pressure and solution is forced through the lines and taps.

Double Container Kits include 2 one-gallon containers with handles, 2 container caps with barrel type adapters, and heavy S/S carrier as shown.

Single Container Kits include 1 one-gallon container with handle and 1 container cap with barrel type adapter.

Part#	Description	Cost
DC-1000	Two Sankey (US & Euro)	\$199.95
Single Container Kits		
SC-1000	Sankey (US & Euro)	94.50
Container Parts		
CK-100	Container only	44.95
CK-200	Sankey cap only	68.95
CK-400	S/S carrier only	49.50
CK-500	Large bottom cap "O" ring	2.95



Maxi-Vac Line Cleaning Pumps

#JS300



#JS350

Specially designed for cleaning draft beer and soft drink dispensing systems. Helps prevent mold and bacteria from building up.

Medium Duty Cleaning Pump

- ✓ For direct draw and short run systems (30 feet or less)
 - ✓ Duplex diaphragm pump is self-priming and can run dry without damage
 - ✓ Resistant to acid-based cleaners
 - ✓ Sturdy powder-coated steel housing
 - ✓ 16 lbs, 115V, 0.50 Amps with cord.
- #JS300 \$410.00

Heavy Duty Cleaning Pump

- ✓ For systems over 30 feet long
 - ✓ Direct drive pump provides constant flow through longer lines
 - ✓ Pulsating action adds scrubbing motion
 - ✓ Motor is totally enclosed
 - ✓ Powder coated all-steel frame
 - ✓ 30 lbs, 115V, 5.3 Amps with cord.
- #JS350 \$510.00

Maxi-Vac Parts

Part#	Cleaner Description	Cost
15021	JS300 Cord set	\$12.00
20120	JS300 Switch	10.20
20301	JS300 Base	68.50
20302	JS300 Cover	55.80
20233	Both 6" hose inlet	8.90
20235	Both End strainer (use #2018*)	33.50
30014	JS300 Pump	320.00
30102	JS350 Frame	53.95
30121	JS350 Cord set with switch	30.50
30239	Both Cleaning adapter	13.95
30330	Both Ball valve	21.95
40012	JS350 Pump	270.00
40013	JS350 Bearing and cam	31.95
40110	JS350 Motor	264.00
50042	Both Discharge hose	17.50
5020-1	JS300 Quick coupler	18.50

*pack of 5

More Parts Available You Don't See It, Ask!

Cleaning Kit Components

#254
Straight cleaning attachment with $\frac{5}{16}$ " nipple (may be used with other 216 series nipples) and #753 washer.

1-5 \$5.15
6-UP \$4.05

#753
Washer, used with #254 straight cleaning attachment.

1-24 \$0.20
25-UP \$0.17

#24R
Rubber washer, used with hex nuts, wing nuts, etc.

1-99 \$0.18
100-249 \$0.16
250-UP \$0.12

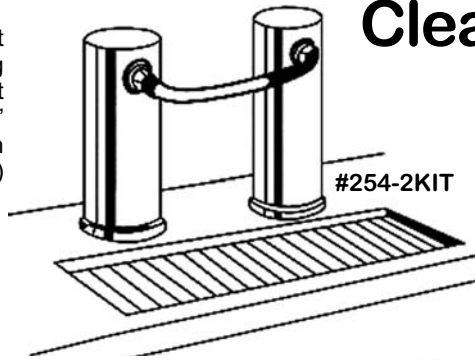

#254-2KIT
Used for connecting one tower to another. Kit includes two #254 straight cleaning attachments, 2 feet of $\frac{5}{16}$ " vinyl tubing and clamps. May be modified to your specifications \$9.45

#4352T
Threaded cleaning attachment with faucet threads on one side and male beer threads on the other. Flat sides for wrench hold. \$13.75

New!! #SS-252 ALL S/S Duplex Coupling
Wider wing tabs are easier to work with. Wings are solid and have silicone caps that are gentler on thumbs.

1-5 \$10.95
6-UP \$10.25

#132
 $\frac{3}{8}$ " Beer "Y"
\$13.95

#4132-252
Four #132 Beer "Y"s and one #252 duplex coupling ganged together with #24R washers. \$61.95

#PCM-66
Metal 6-way cleaning connector \$36.95

#GH58
Garden hose coupling with $\frac{5}{8}$ " barb and washer \$1.95

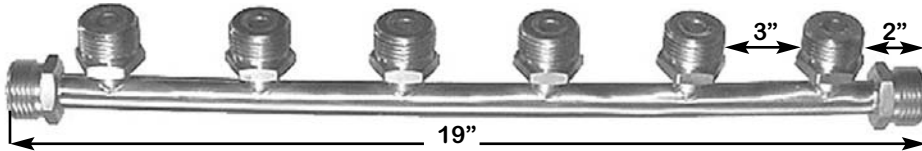

#SS-BMC-8 8-way stainless steel beer cleaning manifold. Great for cleaning 8 lines at a time or 6 lines with an inlet and outlet to link to another manifold. Spaced with ample room for wing nuts. High volume $\frac{1}{2}$ " ID main tube with $\frac{3}{8}$ " branches \$49.95

#FT874C Hex Nut Cap and Washer. Use on male beer thread to block multiple product cleaning connectors (#PCM-66 or #SS-BMC-8) or convert single flusher to series cup. \$4.25



#934
Sankey Double Flusher connects two couplers so that two lines can be cleaned at once \$63.95



#938
Sankey Single Flusher \$26.50

#109S Double flusher adapter. Beer thread ends permit two single flushers to be coupled together to form a double flusher. \$19.95

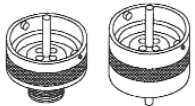

#43681-PK
Perlick Double Cleaning Adapter. \$27.50

#43657PK Perlick Single Cleaning Adapter. Male hex threads on bottom. \$25.50

#CC401L Plastic Series Cleaning Cup. Used for cleaning Sankey taps in series \$6.95



#85-117
Ball Lifter. Inserts into the bottom of the tap probe to lift ball check valve, permitting cleaning from the faucet through the tavern tap \$2.25

Wrenches and Tools



#1350



#1350C



New!
#1350SP



#BMW-1



#FT-1000



#FT-1000-3



#32474-1PK



#FT-8612

Part#	Description	1-11	12-99	100-UP
1350	Wrench with red plastic handle	\$2.95	\$2.75	\$2.45
1350C	Wrench without plastic handle	1.80	1.45	1.25
FT-1000	Faucet/Hex nut wrench	11.95	10.95	N/A
FT-1000-3	Faucet/Hex nut wrench & screwdriver	8.55	7.55	N/A
1350SP	Heavy duty wrench w/ steel pin	9.95	8.95	N/A
FT-8612	Hex Nut/Probe wrench	5.65	4.65	N/A
BMW-1	Beer mechanic wrench	16.95	N/A	N/A
32474-1PK	Perlick Probe/hex nut wrench	7.95	N/A	N/A

Brushes

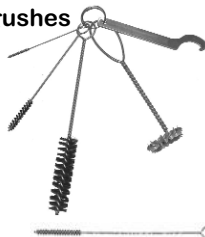

#FVHB-1 Faucet Vacuum Hole Brush. Only $\frac{1}{8}$ " in diameter x 4" long. \$2.55



#SPB-1 Small Probe Brush $\frac{9}{32}$ " diameter x 6" long \$2.85



#1329 Nylon Bristle Faucet Brush $\frac{3}{4}$ " diameter x $8\frac{1}{2}$ " long

1-11 \$2.05
12-99 \$1.85
100-UP \$1.65



#1350WKRH Faucet Spanner Wrench with key ring hole \$2.25

#BRUSH-SET
Includes #FVHB-1, #SPB-1, #1329 and #RCB-1 brushes and #1350WKRH wrench on a key ring. \$9.95

#RCB-1 Round Coupler Brush \$3.95



Hose Brushes (all 66" long)

Model#	Size	1-11	12-UP
904A	$\frac{3}{16}$ " ID	\$3.95	\$3.25
904B	$\frac{1}{4}$ " ID	3.95	3.25
904C	$\frac{3}{8}$ " ID	4.05	3.35

NEW!!

#SS-1329 SS Bristle Faucet Brush $\frac{5}{8}$ " diameter x $8\frac{1}{2}$ " long
1-11 \$3.59
12-UP \$3.37